



SEBO AIRBELT D

MADE IN GERMANY

OWNER'S MANUAL

For Household Use Only



TABLE OF CONTENTS

| | |
|---|-----------|
| Technical Details | 2 |
| Important Safety Instructions | 3 |
| Special AIRBELT D Product Features | 4 |
| ET Power Heads Product Features | 5 |
| Optional DISCO Floor Polisher Product Features | 6 |
| Optional Attachments, Accessories, Bags and Filters | 6 |
| Identification of Parts | 7 |
| Standard Attachments | 7 |
| Optional Attachments | 7 |
| Assembly | 7 |
| Operating Instructions | 8 |
| Starting the machine with a non-power head attached | 8 |
| Additional Instructions for starting the machine with a power head attached | 8 |
| Suction Control | 9 |
| Adjusting the Telescopic Tube | 9 |
| Using the Telescopic Tube, Hose & Attachments | 9 |
| Bag Full or Clog Indicator & Auto Shut-off | 9 |
| Retracting the Cord | 10 |
| LED Suction Power Indicator | 10 |
| Storing the Vacuum | 10 |
| Use and Maintenance of Brushes and Heads | 10 |
| The Parquet Brush | 10 |
| The Optional Premium Parquet Nozzle | 10 |
| The Optional Kombi Nozzle | 10 |
| The Optional Turbo Nozzle | 10 |
| Vacuum Maintenance | 11 |
| Changing the Filter Bag | 11 |
| Changing the AIRBELT | 11 |
| Changing the Motor Filter | 12 |
| Changing the Hospital-grade Micro Filter | 12 |
| Clog Removal | 13 |
| Clogs in the Head or Brush | 13 |
| Clogs in the Telescopic Tube | 13 |
| Clogs in the Hose | 13 |
| Clogs in Entrance to Filter Bag | 13 |
| Trouble-Shooting Guide | 14 |
| AIRBELT D4 Schematic and Part Numbers | 15 |
| Warranty | 16 |
| How To Contact SEBO | 16 |

TECHNICAL DETAILS

| | |
|-----------------------|----------------------|
| Vacuum motor | 1250 watts (12 amps) |
| Water lift (at motor) | 95 inches |
| Airflow (at motor) | 120 CFM |
| Filter bag capacity | 1.5 gallons |
| Sound level | 61 dBA |
| Body weight | 15.9 lbs |
| Motor protection | Thermal cut-out |
| Cord length | 40 feet |
| Range | 50 feet |

Technical details may be subject to change.

IMPORTANT SAFETY INSTRUCTIONS



READ ALL INSTRUCTIONS BEFORE USING THIS MACHINE

When using an electrical appliance, basic precautions must always be followed.

To reduce the risk of electric shock, this vacuum cleaner has a polarized plug; one blade is wider than the other. This plug will fit in a polarized outlet only one way. If the plug does not fit fully in the outlet, reverse the plug. If it still does not fit, contact a qualified electrician to install the proper outlet. Do not change the plug in any way. Connect only to the outlet type specified on the serial number plate underneath the machine.

SAVE THESE INSTRUCTIONS.

WARNING: To reduce the risk of fire, electric shock, or injury:

1. Do not leave vacuum while plugged in. Unplug from outlet when not in use and before servicing.
2. Do not use outdoors or on wet surfaces.
3. Do not use near small children or pets. Do not allow to be used as a toy. Use of this product by children should always be supervised by an adult.
4. Use only as described in this manual. Use only manufacturer-recommended attachments.
5. Do not use with a damaged cord or plug. If vacuum is not working as it should, has been dropped, damaged, left outdoors, or dropped into water, take it to a SEBO service center.
6. Do not pull or carry by cord, use cord as a handle, close a door on cord, or pull cord around sharp edges or corners. Do not run vacuum over cord. Keep cord away from heated surfaces.
7. Do not unplug by pulling on cord. To unplug, grasp the plug – not the cord.
8. Do not plug in if switch is in the “+” (ON) position.
9. Do not use outlets above counters to plug in vacuum – damage to items in the surrounding area could occur.
10. Always carry the vacuum over steps and sills.
11. Do not handle plug or vacuum handle with wet hands.
12. Do not put any object into vacuum openings. Do not use machine with any openings blocked. Keep openings free of lint, hair, and anything that may reduce air flow.
13. Do not re-use filter bags or wash the filters.
14. Do not remove any screws from vacuum.
15. Do not vacuum up anything that is burning or smoking, such as cigarettes, matches, or hot ashes.
16. Do not use vacuum without filter bag and/or filters in place.
17. Turn off all machine controls before unplugging.
18. Use extra care when cleaning on stairs.
19. Do not use machine to vacuum up flammable or combustible liquids such as gasoline or use in areas where they may be present.
20. Machines can cause a fire when operated near flammable vapors or materials. Do not operate this vacuum near flammable fluids, dust or vapors.
21. Maintenance and repairs must be done by qualified personnel.
22. Use only original SEBO replacement parts.
23. Do not use vacuum as a step.
24. If vacuum is used on plush carpet or carpet with thick padding, do not leave machine standing in one place with machine turned on.
25. While the vacuum is in use, the power cord should be unwound from the cable reel at least two thirds of its length. Hold plug when rewinding onto the cord reel. Do not allow plug to whip while rewinding.
26. Keep hair, loose clothing, fingers, and all parts of body away from vacuum openings and moving parts. Do not place fingers or other body parts under vacuum unless it is unplugged.
27. Do not place the power head over rug or carpet edges.
28. The vacuum has a manual reset thermal protector. The protector is reset by switching off the vacuum. The thermal protector needs some time to cool down after switching off! Check the vacuum for air blockages or mechanical failures before switching on.
29. Store the vacuum in a dry place at room temperature. When the vacuum is not in use, you should rewind the cord onto the cord reel.
30. Any other servicing should be performed by an authorized service representative.
31. The hose contains electrical wires. Do not use if damaged, cut, or punctured. Avoid picking up sharp objects.
32. Always unplug vacuum before connecting or disconnecting either hose or power head.
33. Use a SEBO power head only in combination with a SEBO vacuum cleaner.
34. Do not connect power head to a malfunctioning or damaged vacuum.

SEBO AIRBELT D4 PRODUCT FEATURES

The SEBO AIRBELT D4 is equipped with many extras that will make your life easier! Its "suction-optimized" airflow pathway, together with its one-of-a-kind tapered-hose technology, provides ultra-quiet operation and amazing suction power. And the ergonomically designed handle offers unmatched user comfort and smooth operating maneuverability. Every detail expresses the highest quality, modern design, reliability, and the standard features SEBO customers throughout the world have come to expect, such as:

- SEBO's patented AIRBELT Bumper Guard.
- A power head with amazing steering ability and easy brush roller removal.
- An adjustable telescopic tube with internal power cord.
- Long-lasting motor life, which is further extended by its soft-start switch.
- S-class, hospital-grade filtration, which is excellent for users with allergies or asthma.
- Available in three colors: black, red and white.
- A generous five-year warranty on both labor and all non-wear parts.

SEBO Vacuums Save Money! – SEBO vacuums are the highest quality machines available. In fact, if properly maintained, SEBO vacuums can save ordinary residential users hundreds of dollars by providing excellent performance for ten to fifteen years or more. Typical vacuums perform poorly and usually do not last beyond two years. So, in the long run, SEBO vacuums cost less money than the five to six other vacuums purchased during that time period.

Outstanding Warranty Coverage – SEBO is confident about the quality of all its vacuums. Therefore, all models include a five-year warranty on the motor and all non-wear parts.

Bag Full or Clog Indicator & Auto Shut Off

The "BAG FULL OR CLOG" indicator (located on top of the canister near the ON/OFF power control knob) will turn orange and the machine will automatically shut off when it senses a full bag, a clog in the airflow pathway, or an excessively dirty micro filter. If the user ignores this warning, the suction motor will heat up due to the lack of cooling provided by the airflow. Once the motor reaches a certain temperature it will shut off to protect itself from damage. The user should turn the switch off, unplug the machine and immediately insert a new bag or remove the clog (to remove a clog, refer to the Clog Removal section on page 13). After approximately 30 minutes, the motor will have cooled and the vacuum can be restarted.



High-quality Telescopic Tube and Hose – On the AIRBELT D4, the power cord is built inside the telescopic tube and suction hose. This eliminates unsightly external wires and enables unobstructed and convenient handle height adjustment.

Variable Power Control on Handle – The vacuum's suction power can be adjusted from 0 to 1,250 watts by a slider switch conveniently located on the handle.



Comfortable Ergonomic Handle – The AIRBELT handles are ergonomically designed and positioned to reduce wrist and arm fatigue. For extra comfort, an additional swivel is built into the handle-to-hose connection.

Quick-release Connections – The AIRBELT D4 models allow for quick and convenient connection of telescopic tubes, power brush heads, accessory cleaning heads and on-board tools.

LED Suction-power Indicator – The indicator tells the user with a glance how much suction power they are using. The light rotates slower or faster depending on the suction setting.



Powerful Vacuum Motors Provide Excellent Cleaning – The canister suction motor is 1250 watts, and the ET-1 power head motor is 175 watts, for a total of 1,425 watts. The ET-2 power head is 200 watts for a total of 1450 watts.

320-Degree Rotating Hose – A brilliantly designed hose-to-canister connection allows 320-degree rotation of the suction hose, providing easier user movement and machine maneuverability.



Shock Absorber Provides Furniture and Wall Protection – The patented "AIRBELT" bumper that surrounds the D4 canister acts as a protective barrier. The soft foam bumper with its durable covering protects furniture, walls and the vacuum itself from damage during use.



Personalized Vacuums – AIRBELT canister vacuums can be personalized with a replacement AIRBELT bumper cover available in eight patterns and colors.

Rubber Coated Wheels and High Quality Castors – The quality of the wheels and castors on SEBO canisters prevent damage to floors and rotate 360° for easy maneuverability.



Large Operating Range – A 40-foot cord with a 50-foot cleaning radius saves time because it minimizes the number of electrical outlets needed during use.

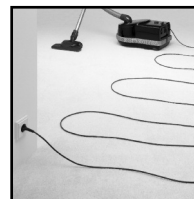

Three Full-Size On-board Tools and Parquet Brush – The vacuum comes standard with a crevice tool, dusting brush and upholstery nozzle which are conveniently stored on the vacuum. Also included with the D4 is the Parquet Brush for gently cleaning hard floors. It is lightweight with soft bristles, so it glides gently over floors. Many optional accessories are also available.



SEBO AIRBELT D4 PRODUCT FEATURES

Liberation from Bagless! SEBO Bags are Hygienic

– The three-layer filter bag is an integral part of SEBO's filtration system because it effectively contains nearly all dirt captured by the vacuum. SEBO bags can be sealed when full, so no dust can escape into the air during disposal. In contrast, a lot of dust becomes airborne when emptying the dirt containers of bagless vacuums, and their micro filters quickly clog and must be replaced often, or a loss of suction will occur. Bagless vacuum micro filters are expensive, usually costing much more than SEBO's filter bags.



A Huge 1.5-Gallon Filter Bag

– The large-capacity filter bag is convenient and economical because fewer bag changes are needed. **Micro Filters are Inexpensive and Easy to Change** – Unlike most other vacuums, SEBO's replacement micro filters are reasonably priced and can be easily changed in seconds, without any tools. And the micro filters last a long time before replacements are necessary because nearly all dust particles and debris are first captured by the three-layer filter bags.



Anti-allergy Hospital-grade, S-class Filtration

– An excellent choice for users with allergies or asthma. Certified by leading Allergy foundations in Europe, the AIRBELT D4 vacuums provide the user with S-Class filtration of 99.9% of particles to 0.3 microns. This is accomplished by the SEBO three-step filtration system. First, the three-layer full-size filter bag (a) collects the vast majority of the debris. Then, the remainder of the particles are collected by the motor filter (b). Finally, the hospital-grade micro filter (c) cleans the exhaust air that the vacuum emits. The AIRBELT (d) disperses the filtered exhaust air around the canister which provides quiet, gentle air flow. SEBO's unwavering attention to the complete sealing of the machine ensures no dirt escapes around the microfilters.

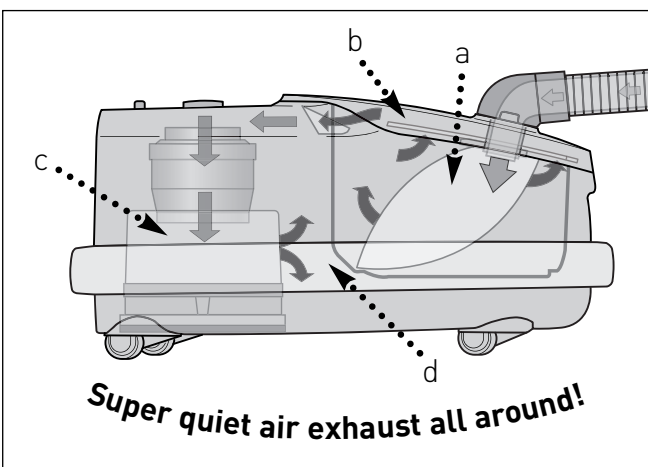

Effective Pet Hair Removal – All SEBO vacuums easily remove pet hair.



Remarkably Quiet Operation – Intelligent design and high-quality motors combine to provide amazingly quiet vacuums.

ET Power Heads - Designed for All Floor Surfaces.

Deep clean your carpet with a SEBO ET power head. SEBO power heads are virtually maintenance free, and their electronic overload protection feature extends belt life by automatically shutting off power, if a brush roller jams. These power heads deliver cleaning flexibility because their brush action aggressively cleans carpeting, and the brush may be switched off to clean hard floors and delicate rugs. The steering ability of the swivel necks help to easily clean around obstacles, and their L-shaped heads provide maneuverability around furniture and under cabinets. They also have brush height and brush wear warning lights.



Cleaning Dimensions – The ET-1 power head is 12-inches wide, with a cleaning width of 10 1/2-inches, and the ET-2 is 14 3/4-inches wide, with a 13-inch cleaning width.

Brushless Cleaning Capability – The ET-1 or ET-2 power heads can provide gentle, brushless cleaning of delicate rugs or hard floors because the brush roller may be switched off, but suction will continue.

Brush Obstruction Light & Auto Shut Off – If an obstruction becomes jammed in the brush roller, a warning light will quickly flash, the brush roller will immediately stop spinning and the vacuum will shut off. The user should turn the power switch off, unplug the machine, and immediately remove the obstruction. If the user restarts the machine without removing the obstruction, the power head will again shut off and the amber light will turn on. This prevents the belt from breaking and protects the motor from damage.



Incorrect Height Setting or Brush Deterioration Light

– To ensure optimum cleaning at all times, a warning light will illuminate to indicate when the brush height is set too high for effective cleaning, or when the brush roller should be replaced due to excessive wear.

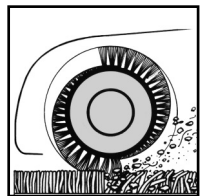

Four-level Manual Brush Height Adjustment – The brush height can be adjusted up or down for optimum cleaning.

Both Carpet and Hard Floor Cleaning – With a power brush to clean carpets and a parquet nozzle to clean hard floors, the AIRBELT D4 provides all the flexibility needed to care for a variety of floor surfaces. The D4 vacuum can morph into a hard floor polisher, by adding a SEBO DISCO head.

SEBO DISCO FLOOR POLISHER - OPTIONAL FOR THE AIRBELT D4

Polish your hard floor with a SEBO DISCO Ultra-High-Speed floor polisher!

The SEBO DISCO (13" wide, 11 3/4" polishing width) – It's never been easier to make hard floors shine! The SEBO DISCO floor polisher can both vacuum and polish, for a super-gloss finish. It can be attached to the FELIX uprights or to the AIRBELT canisters. Its suction removes fine dust (dust from fully dried floor polishing product) during polishing, and the 2,000 rpm disc speed will create a high-gloss shine for a fantastic hard floor finish.

DISCO FEATURES:

SEBO floor pad - Brilliance at work. The SEBO floor pad has been developed to achieve the optimum polished finish on all suitable surfaces. In addition, the floor pad is easy to change and maintain.



Automatic height adjustment - Every hard floor is different. The SEBO DISCO adjusts the floor pad automatically to different floor conditions. The torque of the rotating floor pad is constantly measured for best adjustment. A vacuum seal around the base of the polisher ensures that even the finest dust gets drawn into the intake flow.

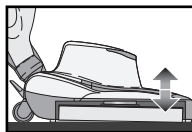

Automatic shut off - Intelligent safety. The SEBO DISCO is a smart machine. The green LED light indicates that the SEBO DISCO is operational and everything is ok. The red LED light comes on if the machine has shut down for safety reasons, for example if there is a blockage



A Soft Bumper - Care everywhere. Every room has obstructions. That is why the SEBO DISCO has a soft bumper. Furniture and walls are protected against scratches and marking.

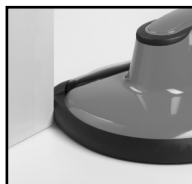

A highly maneuverable swivel neck and three castor design - glides over the floor.

Three high quality castors support the SEBO DISCO. At the rear are two 360° flexible castors which are fixed on a solid steel shaft. A castor in the middle helps the SEBO DISCO to stay on the right track. Working with the flex neck, they give the SEBO DISCO its supreme maneuverability. The castors are rubberized to prevent skidding and to protect the floor.



Immediate retention of polishing dust by the suction unit.

Reinforced drive disc that provides optimal floor contact and a speed of 2,000 rpm.



SEBO DISCO White
Part #9430AM



SEBO DISCO Black
Part #9433AM

OPTIONAL ATTACHMENTS, ACCESSORIES, BAGS & FILTERS

In addition to the standard on-board tools, a variety of optional attachments are available. The nine-foot extension hose (extends suction hoses) and the 20-inch extension tube are very popular because they create useful tools for cleaning stairs and out-of-reach areas. These two items are sold separately or as part of multiple item attachment kits. Another popular attachment is the hand-held turbo brush for removing pet hair from upholstery and stairs. See page 10 for more information on the Premium Parquet, Kombi and TT-C Turbo Nozzles.

SEBO filter bags can be purchased in boxes of eight and filters are sold as a set. SEBO bags, filters and accessories are reasonably priced and widely available.

To create a fresh scent while vacuuming, "SEBO FRESH" is available. To use, deposit a scented stick in the filter bag.

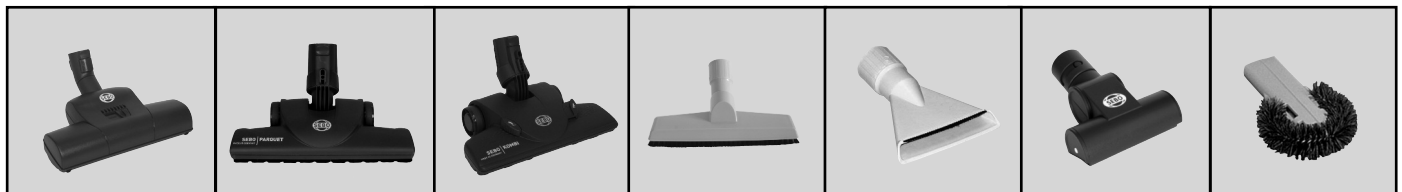

TT-C Turbo Nozzle

Premium Parquet Nozzle

Kombi Nozzle

Wall & Floor Brush

Flat Upholstery Nozzle

Hand-held Turbo Brush

Radiator Brush

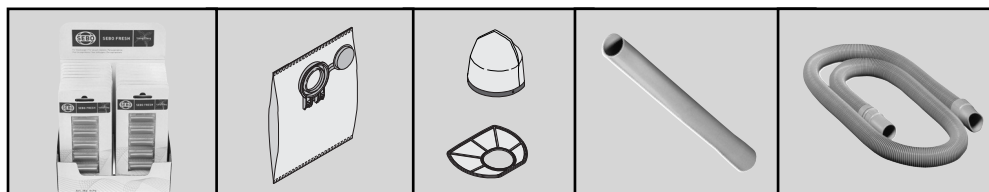

SEBO FRESH

Filter Bags

Filters

Extension Tube

Nine-foot Extension Hose

IDENTIFICATION OF PARTS

- | | |
|--------------------------------|-----------------------------|
| 1. Handle grip | 14. Hose neck |
| 2. Power control slider | 15. Cover release catch |
| 3. Handle release button | 16. Carrying handle |
| 4. Slide Button | 17. AIRBELT shock absorber |
| 5. Telescopic tube | 18. Filter bag cover |
| 6. On/Off button | 19. Suction opening |
| 7. Cable rewind button | 20. Parking groove |
| 8. LED suction-power indicator | 21. Power cable |
| 9. Tool release button | 22. Dusting brush |
| 10. Kombi nozzle (optional) | 23. AIRBELT clip |
| 11. Hose | 24. Upholstery nozzle |
| 12. Bag full or clog indicator | 25. Crevice nozzle |
| 13. Hose neck release tabs | 26. Carrying/Parking groove |
| | 27. Micro filter holder |

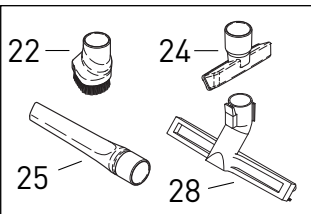

Standard Attachments & Heads

- | | |
|-----------------------|--------------------|
| 22. Dusting brush | 25. Crevice nozzle |
| 24. Upholstery nozzle | 28. Parquet brush |

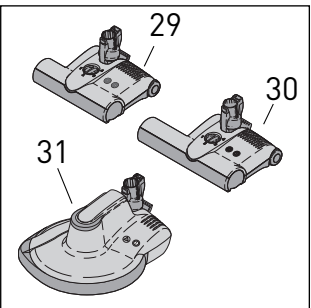

Standard & Optional Power Heads

29. ET-1 Power head - Standard on Premium D4 Black and Premium D4 White
Optional for D4 Red: Part #9299AM
30. ET-2 Power head - Optional for D4 Red: Part #9250AM
31. DISCO - Optional for all D4 vacuums
Black: Part #9433AM
White: Part #9430AM

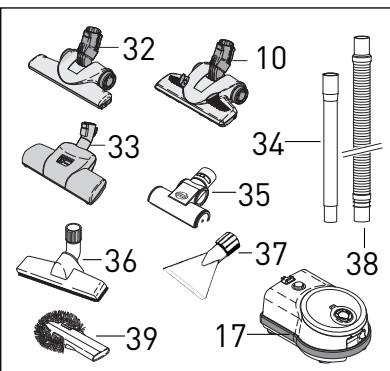

Optional Brushes, Heads & Attachments

32. Premium Parquet nozzle - Part #7200DG
10. Kombi nozzle - Part #7260DG
33. TT-C Turbo brush - Part #6780ER
34. Straight tube (20 in.) - Part #1084HG
35. Hand-held Turbo brush - Part #6179DA
36. Wall and floor brush - Part #1325HG
37. Flat Upholstery nozzle - Part #1090HG
38. Extension hose (9 feet) - Part #1495AM
39. Radiator brush - Part #1496DG
17. AIRBELT - Available in several colors and patterns - Part #6047AM/01-08

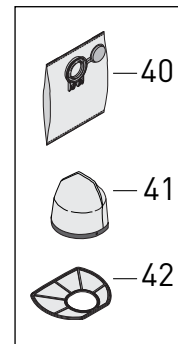
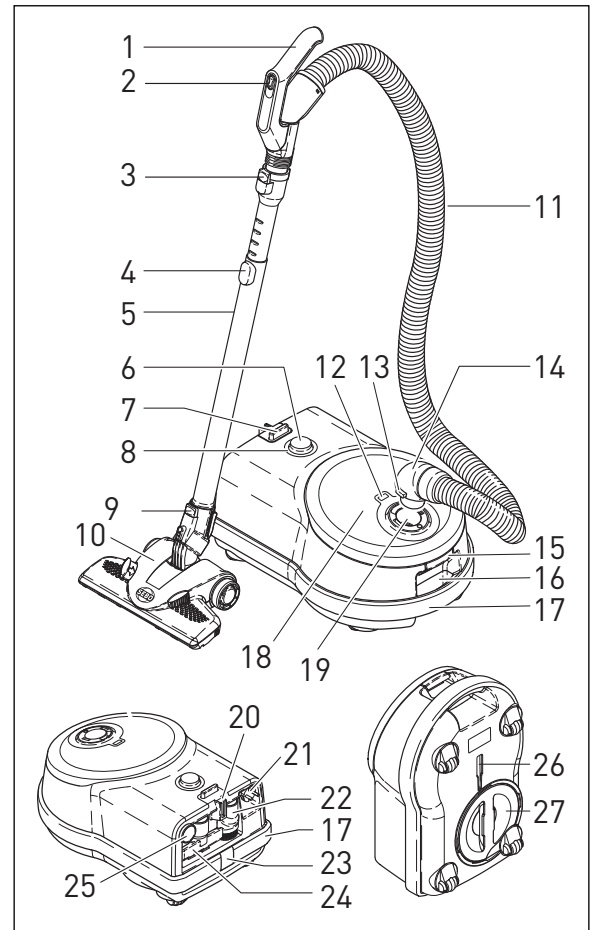

Filters & Filter Bags

40. Filter Bag
Filter Box D
incl. 8 filter bags - Part #8120AM
41. Hospital-grade Micro Filter
42. Motor Filter
Micro Filter Box
incl. 1 micro filter and 1 motor filter - Part #8191AM

ASSEMBLY

Push the neck (14) of the hose (11) into the suction opening of the canister (19). When all four notches are lined up correctly, the neck will snap firmly into place. To release the hose from the suction opening, squeeze the release tabs (13) on both sides of the neck of the hose (14), and pull the neck out.

Connect the handle grip (1) to the top of the telescopic tube (5). Snap in place. To release the telescopic tube (5) from the handle grip, push the handle release button (3) and slide the handle out.

Attach the head or brush to the bottom of the telescopic tube (5). Insert the bottom of the telescopic tube into the neck of the head or brush (10) until it locks into place; or line up the square hole in the telescopic tube with the notches in the front of the neck, and snap firmly into place. To release a head or brush from the telescopic tube (5), push the head release button (9), and pull the head or brush tool off the end of the telescopic tool. The release button (9) is in the same position on all of the heads, brushes and power heads.

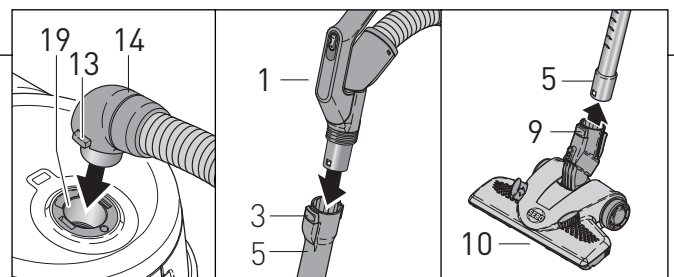

NOTE: To attach a SEBO power head (ET-1, ET-2 or DISCO) to your D4 canister, please refer to your power head owner's manual for instructions. Attaching incorrectly could cause damage!

OPERATING INSTRUCTIONS

Starting the machine with a non-power-head attached - Figures 1, 2 & 3

Before turning on your canister, make sure that you have a firm hold on the handle grip to keep the machine from moving forward.

1. With the canister On/Off button (6) in the OFF position, and the power control button (2) on the handle grip (1) in the OFF (-) position, grasp the plug and pull the power cord (21) out from the power cable recess (figure 3). The power cord (21) should be unwound from the cable reel at least two thirds of its length. **Note:** do not over-extend the cord.
2. Plug the polarized power cord into a 120 volt wall outlet located near the floor.
3. Press the canister On/Off button on the base of the canister (6) gently with your foot or hand. The blue light around the button (8) will blink right and left indicating that the power is on. Your SEBO AIRBELT D4 has a soft-start system for longer component life. This may delay starting slightly.

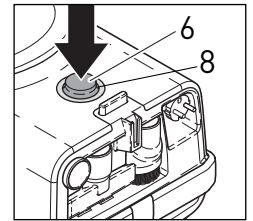

Figure 1

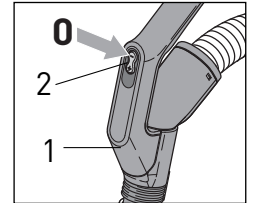

Figure 2

Always turn the power off on the canister AND the power head when changing heads or unplugging the vacuum. Press the minus (-) on the power control button (2) on the handle grip until the suction stops, press the On/Off button (6) on the base of the canister gently with your foot or hand, then unplug the canister to completely shut down the power when changing heads or storing the vacuum.

Continue to page 9.

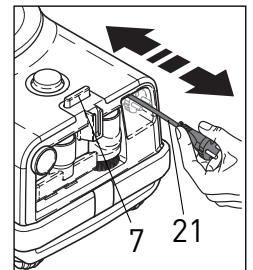

Figure 3

Additional instructions for starting the machine with a power head attached - Figures 1, 2, 3, 4, 5 & 6

Please refer to your ET or DISCO power head owner's manual for more information.

Before turning on your canister, make sure that the vacuum handle is in its upright locked position (figure 4). Follow steps 1-3 above.

When the power head is switched on with the handle in the upright locked position (figure 4), the brush roller on the power head will not spin.

To release the power head from the upright locked position, press down on the foot pedal (#43, figure 5) and lower the handle into the normal operating position. Push the brush roller button on the top of the power head (#44, figure 6) to engage the brush roller. The green light on the power head will illuminate.

When the canister On/Off button (#6, figure 1) is in the ON position, you may turn the power head off and on using the power control button (#2, figure 2) on the handle. To turn the power head off using the power control button on the handle, push the minus (-) button until the suction stops. The green light (44) on the power head will then shut off. The blue light (8) on the canister will remain illuminated until the vacuum is powered off using the On/Off button on the canister (6).

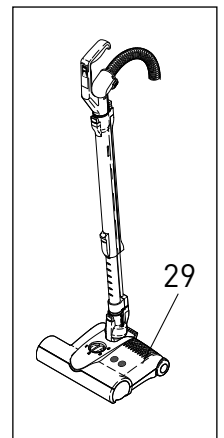

Figure 4

Always turn the power off on the canister AND the power head when changing heads or unplugging the vacuum. Press the minus (-) on the power control button (2) on the handle grip until the suction stops, press the On/Off button (6) on the base of the canister gently with your foot or hand, then unplug the canister to completely shut down the power when changing heads or storing the vacuum.

Continue to page 9.

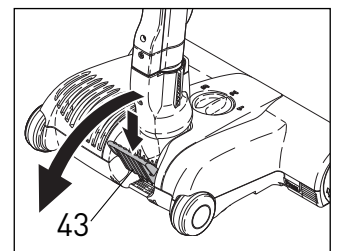

Figure 5

! WARNING! The quality, condition, coating, texture, age and manufacturing technique of all floor surfaces vary. Therefore, vacuums with rotating brushes, including your SEBO, may damage some floor coverings or surfaces. Some types of high-gloss hardwood floors, cushion vinyl, berber carpets, long shag, and delicate or hand-woven carpets are particularly vulnerable to damage by rotating brushes. When possible, consult the materials supplied by your flooring manufacturer for information on proper upkeep and cleaning. **To ensure that your new SEBO vacuum cleaner is compatible with your floor, please test the vacuum cleaner on each type of flooring surface in a small inconspicuous area to determine if any damage occurs. If damage occurs, stop using the vacuum cleaner immediately!**

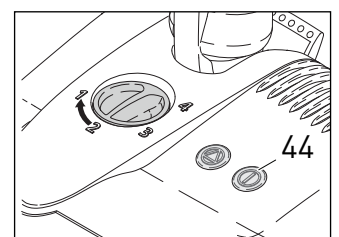

Figure 6

Suction Control - Figure 7

The suction power will automatically increase from standby to maximum power after the machine is switched on. You can override this process by pressing the plus (+) or minus (-) on the power control button (2) conveniently located on the handle grip (1). Press the plus on the button for maximum suction or press the minus to reduce suction for vacuuming curtains or delicate fabrics. You may adjust the suction control with the power control button (2) as you vacuum different surfaces or when using the accessory tools. For optimal cleaning and brushing, operate the machine at the maximum suction power setting and push the head slowly over the carpet.

Adjusting the Telescopic Tube - Figure 8

Adjust the telescopic tube (5) to the correct height by pushing the slide button (4) and gently pulling the tube out to lengthen, or pushing it in to shorten. Release the slide button (4) to lock the tube to the adjusted height.

The handle can be lowered to a horizontal position useful for vacuuming under beds.

Using the Telescopic Tube, Hose & Attachments - Figures 9, 10 & 11

The telescopic tube (5) is useful for vacuuming corners and hard-to-reach areas. You may use the telescopic tube without a brush, power head or attachment. To remove a brush or power head, switch off the canister On/Off button (6) and unplug the vacuum. Then, press the tool release button (9) and pull the tube out. The crevice nozzle (25), dusting brush (22), upholstery nozzle (24) and parquet brush (28) may be inserted onto the end of the tube. It is not necessary to turn off the vacuum while switching the **standard** attachments (the crevice nozzle, upholstery nozzle or dusting brush). After use, switch off the power, unplug the vacuum and remove attachment. Re-insert the telescopic tube into the power head or brush, turning the tube if needed, until you hear it click into place.

NOTE! D4 users with power heads, please refer to your power head user's manual for more detailed instructions for connecting your power head.

To use the hose and handle grip without the telescopic tube, switch off the canister On/Off button (6) and unplug the vacuum. Push the handle grip release button (3) and pull the HANDLE GRIP out of the end of the telescopic tube. Do not try to separate the hose from the handle! Insert the crevice nozzle (25), dusting brush (22) or upholstery nozzle (24) onto the end of the handle. It is not necessary to turn off the vacuum while switching the **standard** attachments (the crevice nozzle, upholstery nozzle or dusting brush). After use, switch off the power, unplug the vacuum and remove the attachment. Re-insert the handle into the telescopic tube making sure it is seated correctly and snap it into place.

The three standard attachment tools are stored in the rear of the machine. Make sure they snap into place firmly. The dusting brush (22) has a rotating head. If it is not fitting into its storage space, rotate the head to another position.

Bag Full or Clog Indicator & Auto Shut-Off - Figure 12

When the "BAG FULL OR CLOG" indicator (located on top of the canister (12)) turns orange, airflow is reduced due to a full bag, a clog in the airflow pathway, or an excessively dirty filter. Turn the power off, unplug the machine and immediately insert a new bag (see page 11) or remove the clog (see page 13).

If the user ignores the orange warning indicator, and the motor reaches a certain temperature, it will shut off to protect itself from damage. The user should turn the power off, unplug the machine and immediately insert a new bag or remove the clog. After approximately 30 minutes, the motor will have cooled and the vacuum can be restarted. If the airflow is still restricted, the "BAG FULL OR CLOG" indicator will turn orange again and the machine will shut off. This feature prevents damage to the motor due to overheating.

Vacuuming fine dust may require an earlier filter bag change even though the filter bag is not full. Fluff may overfill the bag without the light coming on.

The bag full indicator works more efficiently at full power. Check the bag full status regularly at full suction power.

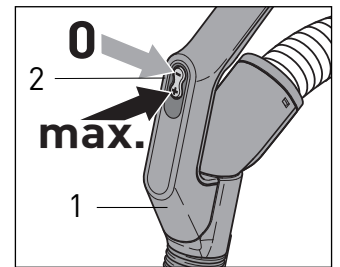

Figure 7

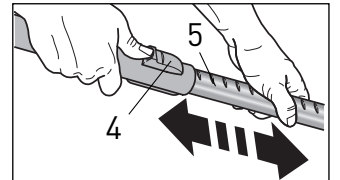

Figure 8

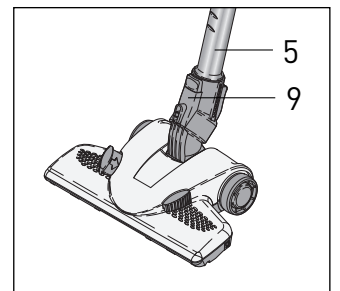

Figure 9

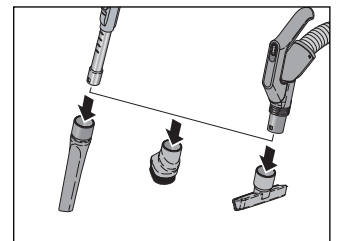

Figure 10

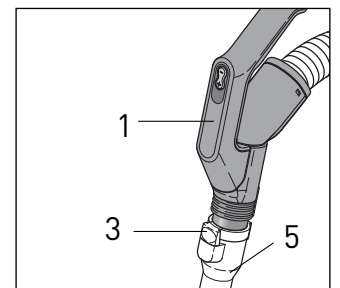

Figure 11

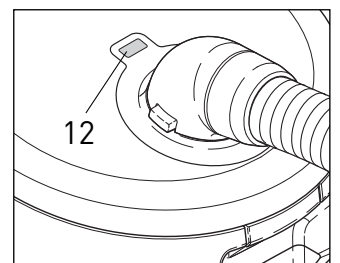

Figure 12

Retracting the Cord - Figure 13

To retract the cord, switch the vacuum off, unplug it from the outlet, then press the cord rewind button (#7, figure 13) and the mechanism will automatically rewind the cord. You must hold the button down until the cord is fully rewound. Hold plug while rewinding into the cord wheel. Do not allow the plug to whip while rewinding. The rewind mechanism will stop automatically when you release the button. Before rewinding the cable, always switch off and unplug the vacuum.

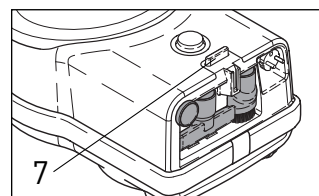

Figure 13

LED Suction-Power Indicator - Figure 14

Your AIRBELT D4 canister features an LED light display (8) that monitors suction power. It is located around the ON/OFF power control knob (6). When the canister power is switched on, a blue light will blink right and left. As the suction increases, the lights will rotate around the ring. The faster the rotation, the higher the suction.

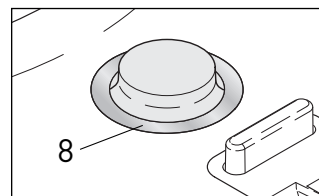

Figure 14

Storing the Vacuum - Figures 15, 16 & 17

The vacuum can be stored with the canister in a horizontal or vertical position. The standard Parquet brush has a parking tab located on the back of the neck. The optional Premium Parquet, Kombi and Turbo nozzles have a parking tab located on the front of the neck (45). Insert the parking tab into the upper side of the parking groove and slide down firmly. For vertical storage or for easy carrying, use the parking slot on the underside (26). For horizontal storage, use the parking slot on the end of the canister (21).

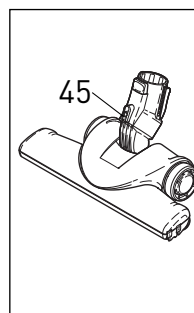

Figure 15

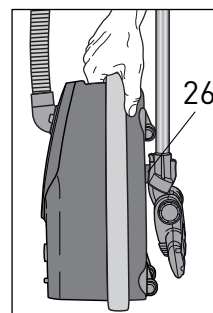

Figure 16

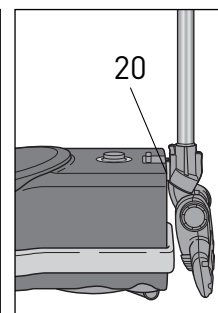

Figure 17

USE AND MAINTENANCE OF BRUSHES & HEADS



Always unplug vacuum from outlet before dismantling any part of machine!
To remove a brush or power head, switch off the power and unplug the vacuum.
Then, press the tool release button (9) and pull the tube out.

NOTE! D4 users with ET-1, ET-2 or DISCO power heads, please refer to your power head user's manual for more detailed instructions for operating and maintaining your power head.

Parquet Brush (standard) - Figure 18

The D4 comes with a parquet brush (28) that was designed specifically for vacuuming hard floors. It is lightweight with soft bristles, so it glides gently over floors and provides easy maneuverability. Fibers and hair can be pulled out of the bristles manually, or vacuum the bristles with the telescopic tube.

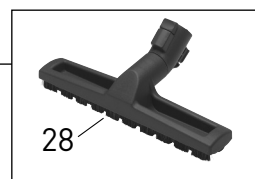

Figure 18

Premium Parquet Nozzle (optional) - Figure 19

The Premium Parquet nozzle (32) is especially designed for use on hard surfaces. The brush should be cleaned regularly. Remove the parquet nozzle from the telescopic tube to clean. Fibers and hair can be pulled out of the bristles manually, or vacuum the bristles with the telescopic tube.

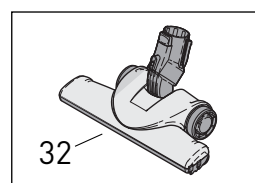

Figure 19

Kombi Nozzle (optional) - Figure 20

The Kombi nozzle (10) is adjustable for carpet or hard floors. To set for carpet, slide the up arrow button (46) to the right until it clicks into place. The hard floor dusting brush will raise up allowing the head to move over the carpet. To set for hard floors, slide the down arrow button (47) to the left until it clicks into place. The brush will lower to gently sweep your floors. **The slider in Figure 20 is set in the position for hard floors.** Remove the Kombi nozzle from the telescopic tube to clean. Fibers and hair can be pulled out of the bristles manually, or vacuum the bristles with the telescopic tube. The brush strip is removable for cleaning and replacement.

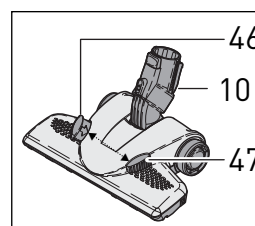

Figure 20

Turbo Nozzle (optional) - Figure 21

The Turbo nozzle (33) has an air-driven rotating brush for gentle brushing of carpets. The Turbo nozzle can be adjusted for high and low pile carpet. To adjust the head for high pile carpet, push the slider button (48) to the right. For low pile carpet, push the slider button (48) to the left. **The slider in Figure 21 is set in the low pile position.** Remove the Turbo nozzle from the telescopic tube to clean. Remove fibers and hair from the brush manually.

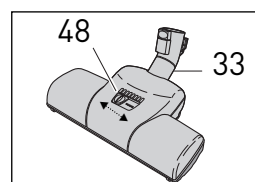

Figure 21

VACUUM MAINTENANCE



Always unplug vacuum from outlet before dismantling any part of machine!

Changing the Filter Bag - Figures 22, 23, 24, 25 & 26

To change the filter bag (40), switch off the power and unplug the vacuum. Lift the cover release catch (#15, figure 22) and raise the filter bag cover (18). Seal the filter bag with the sealing cap (49). Lift the filter bag out of the holder by tilting the green collar (50) up and pulling it out of the holder as shown in figure 23.

Insert the green collar of a new filter bag down into the filter bag holder vertically as shown in figure 25. Line up the tabs (#52, figure 24) with the slots on the green collar (#51, figure 26) and gently push the collar down flat until the center U-shaped clip (#53, figure 24) moves all the way forward. Close the cover, making sure it snaps shut completely. Do not re-use the filter bags.

The “bag full or clog” indicator works correctly only at full power. Check the status of the filter bag regularly at full power.

Note: The nature of the contents of the filter bag will affect the point at which it needs changing. Fine dust may require an earlier change even though the bag is not full. Fluff or hair allows air to pass through easily, so the filter bag may over fill before the “bag full” indicator turns orange.

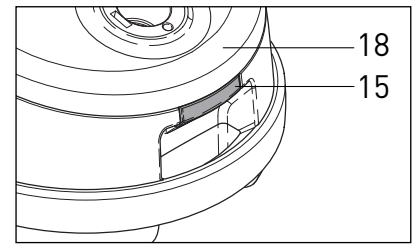

Figure 22

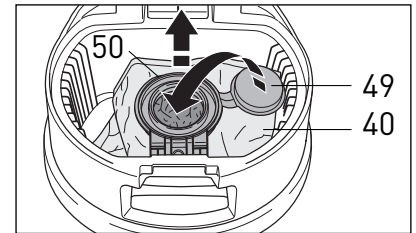

Figure 23

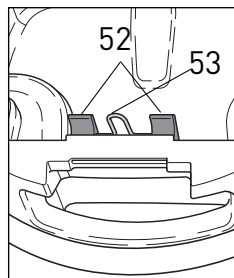

Figure 24

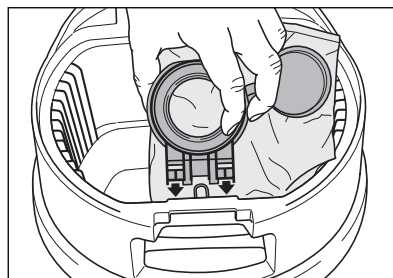

Figure 25

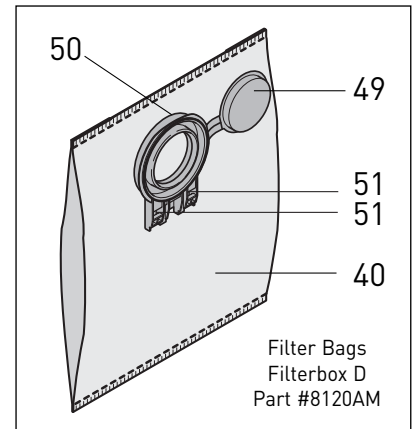

Figure 26

Changing the AIRBELT - Figure 27

If damage occurs to the AIRBELT cover, it will need to be replaced. To remove the AIRBELT (7), pry off the clip (23) by inserting the tip of a slot-head screwdriver under the bottom side of the clip. Push outward carefully on the screwdriver until the clip pops off. Grasp the end of the AIRBELT cover (7) and pull - the AIRBELT cover will peel off. The foam bumper (54) remains on the vacuum. To replace the AIRBELT, insert the side ribs of the AIRBELT into the grooves (55). Start at the back, insert the rib of the AIRBELT cover into one groove (55), and while holding it down, stretch the AIRBELT cover around the foam (54) into the opposite groove (55). Continue around the vacuum. Secure the ends with the clip (23).

SEBO AIRBELT covers are available in a variety of colors and patterns. See your SEBO dealer for available selection.

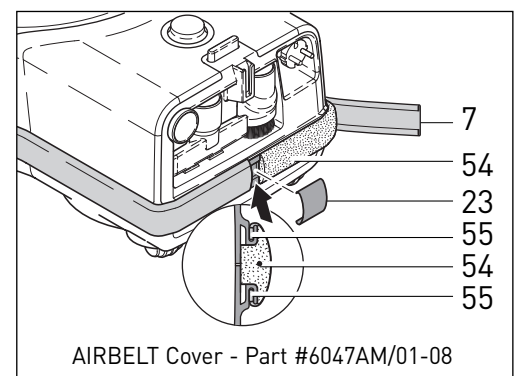

Figure 27

Note: Never operate the vacuum with incorrectly attached filters or without filters, bag, AIRBELT or filter bag housing cover (18). Do not re-use filter bags. Do not wash and re-use filters.

Changing the Motor Filter - Figures 28 & 29

The motor filter (42) needs to be changed when it becomes extremely dirty or clogged. To remove the motor filter, switch off the power and unplug the vacuum. Lift the cover release catch (#15, figure 28) and raise the filter bag cover (18). Pull the filter (42) out by grasping the rubber rim (#57, figure 29) of the filter and pulling it out of the groove (#56, inset, figure 29) that holds it. Fit the new filter into the groove and push the rubber rim snugly into the groove **all the way around the filter edge**. Do not leave any loose edges. Close the filter bag cover making sure that the cover release catch snaps back into place.

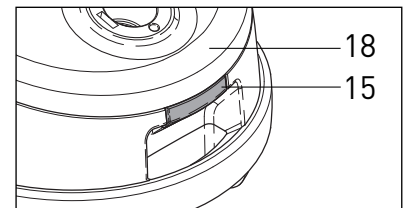
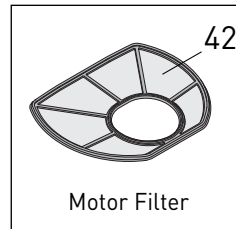

Figure 28



Motor Filter

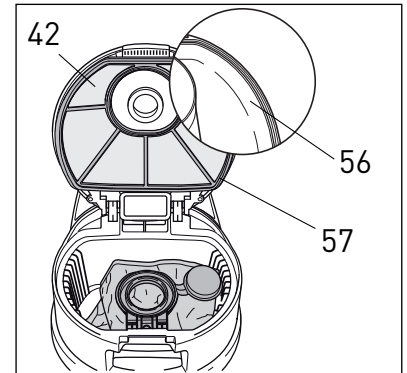

Figure 29

Changing the Hospital-grade Micro Filter - Figures 30, 31, 32 & 33

After 10 to 20 bags have been used, change the micro filter (41). To remove the micro filter, switch off the power and unplug the vacuum. Press the release button (58) located on the filter holder (27) as shown in figure 30. While holding the button in, rotate the holder counter-clockwise and pull it out. Remove the filter (41) from the filter holder (27) by pulling the rubber strip (#59, figure 31) away from the notches (60) that hold it onto the base of the filter holder then pulling the filter off. Fit the new filter down over the holder, lining up the notches (60) on the holder with the holes (61) in the red rubber strip. The two tabs located on the indented portion of the red filter rim hook onto the holder rim (see position #62, figure 32). Tuck the peak of the filter down as shown in figure 31. Insert the assembly back into the machine and turn the holder cover clockwise (figure 33). It is not necessary to press the release button to close the filter holder.

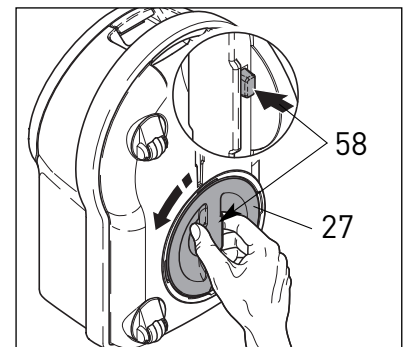
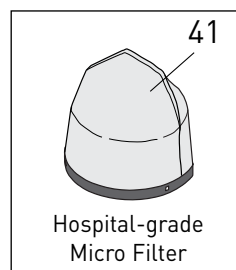

Figure 30



Hospital-grade Micro Filter

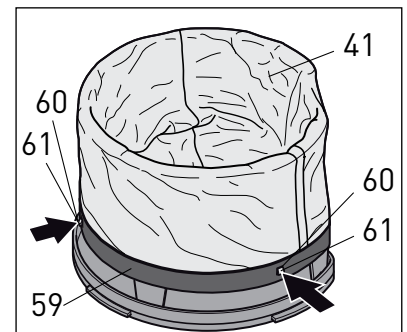

Figure 31

D Filter Set - Motor Filter and Hospital-grade Micro Filter - Part #8191AM

Note: Never operate the vacuum with incorrectly attached filters or without filters, bag, AIRBELT or filter bag housing cover (18). Do not re-use filter bags. Do not wash and re-use filters.

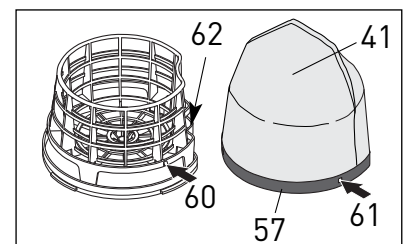

Figure 32

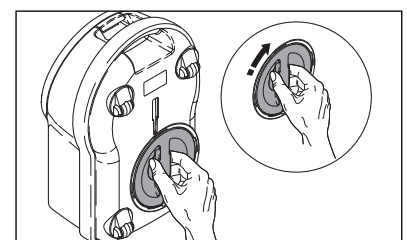

Figure 33

CLOG REMOVAL

⚠ Always switch off power and unplug vacuum from outlet before removing any clogs!

NOTE! D4 users with ET-1, ET-2 or DISCO power heads, please refer to your power head user's manual for more detailed instructions for removing clogs in your power head.

If the "bag full or clog" warning indicator (12) remains orange after the filter bag has been changed and the filters are in good condition, there is likely a clog in the system.

Clogs in the Head or Brush - Figure 34

Clogs in the swivel neck (63) of a head or brush can be cleared by first pressing the tool release button (9) and removing the brush or head. Check inside the swivel neck channel (64), and clean out pathway.

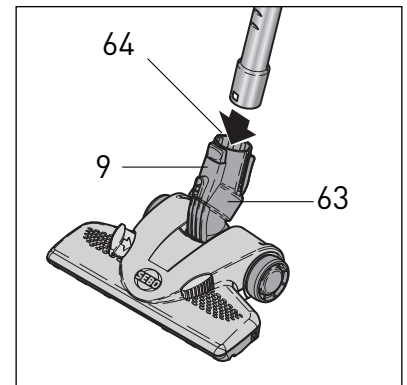

Figure 34

Clogs in the Telescopic Tube - Figure 35

Remove head from telescopic tube (5) by pushing the tool release button (9) and pulling the tube out. Remove the handle grip (1) from the top of the telescopic tube by pushing the handle grip release button (3). A stiff wire or stick can be used to push the clog out of the tube.

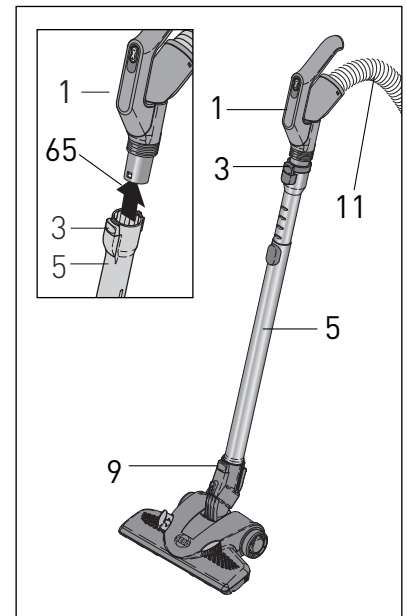

Figure 35

Clogs in the Hose - Figures 35, 36, 37 & 38

Check for suction at the end of the hose by removing the handle grip (1) from the telescopic tube (5) and putting your hand over the handle grip suction opening (65). Turn the power on and slide the suction up to full power. If you feel reduced suction, the blockage is in the hose.

If the blockage is in the hose, there are two ways to clear it:

1. With the telescopic tube disconnected from the handle grip (1), hold the hose upright with one hand blocking the handle grip suction opening (65) and switch on the machine with full suction power. If necessary, quickly lift your hand on and off the end of the hose. If that does not clear the clog, you may also clear clogs by reversing the hose - see #2 below.

2. With the power off, remove the hose neck (#14, figure 36) from the suction opening (19) by squeezing the two release buttons (13). Remove the handle grip (1) from the telescopic tube (figure 37) and insert the handle end of the hose (1) into the suction opening (figure 38). Note: the handle will not fit snugly into the suction opening. Then, hold the hose upright with one hand blocking the hose neck end and switch on the machine at full suction power. If necessary, quickly lift your hand on and off the neck end of the hose (figure 38). After the clog is removed, replace the hose in the correct position.

Note! Do not insert a wire or stick into the hose. Doing so may cause damage to the hose.

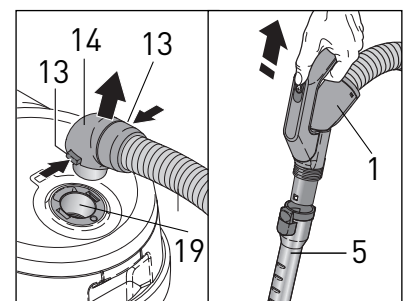

Figure 36

Figure 37

Clogs in Entrance to Filter Bag - Figure 39

Remove hose neck (14) from vacuum cleaner (see figure 36), open the filter bag cover (see page 11) and clean out entrance to bag (66).

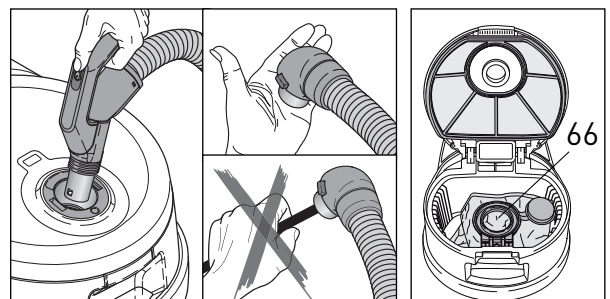

Figure 38

Figure 39

TROUBLE-SHOOTING GUIDE



Always unplug vacuum from outlet before dismantling any part of the machine!

| PROBLEM | REASON | SOLUTION |
|--|---|--|
| Does not turn on | 1. Telescopic tube not inserted properly. | 1. See page 7. |
| | 2. Not plugged into working outlet. | 2. Use another outlet. |
| | 3. Cable worn. | 3. Replace cable. |
| | 4. The power control button switch is set to "-" ("off" position). | 4. Set power control button to "+" position. See page 9. |
| Bag full or clog light on Bag full or clog light on & machine shuts off | 1. Bag full. | 1. Replace filter bag. See page 11. |
| | 2. Clog in hose, telescopic tube, brush or head, or entrance to filter bag. | 2. See Clog Removal on page 13. Users with clog in power head attachment: refer to clog removal in the ET-1, ET-2 or DISCO owner's manual. |
| | 3. Hospital-grade micro filter dirty. | 3. Replace hospital-grade micro filter. See page 12. |
| | 4. Motor filter dirty. | 4. Replace motor filter. See page 12. |
| Does not pick up | 1. Hose/handle assembly not correctly inserted. | 1. Re-insert hose/handle assembly making sure that it is lined up properly and is snapped into place. See page 7. |
| | 2. The power control button switch is set to "-" ("off" position). | 2. Set power control button to "+" position. See page 9. |
| | 3. Filter bag cover not closed. | 3. See below. |
| Filter bag door won't fully close | 1. Filter bag cover not fully closed. | 1. Re-insert bag. Lock the cover down firmly. See page 11. |
| | 2. Bag not inserted properly. | 2. Re-insert bag. Lock the cover down firmly. See page 11. |
| | 3. Motor filter not properly inserted. | 3. Remove the filter bag cover (18) and make sure the motor filter is seated firmly in place all the way around the rim. See page 12. |

AIRBELT D4 SCHEMATIC AND PARTS LIST

90640AM Premium D4 - Black (Onyx)
90641AM Premium D4 - White

90630AM D4 - Red

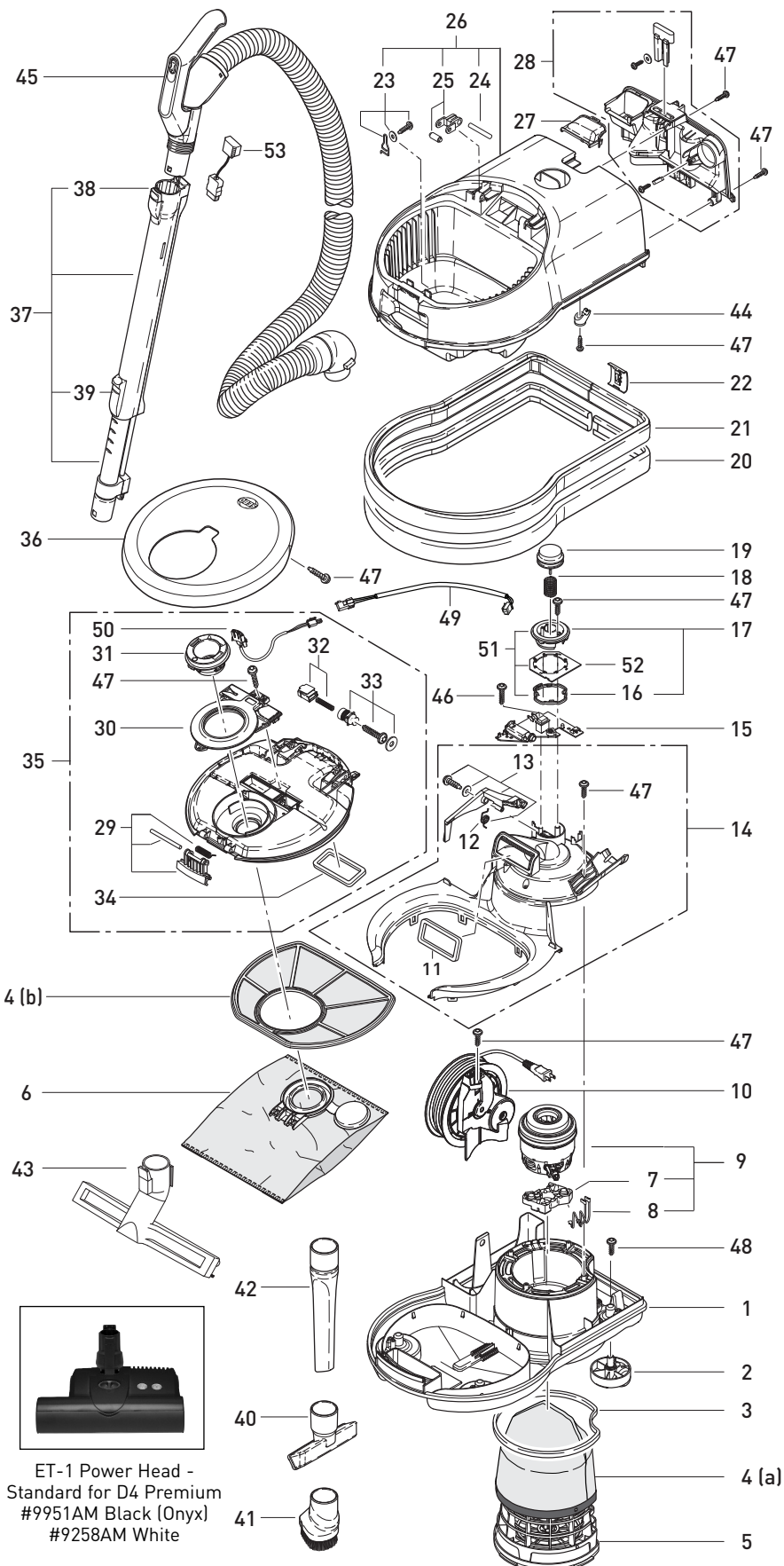

ET-1 Power Head -
 Standard for D4 Premium
 #9951AM Black (Onyx)
 #9258AM White

Optional for D4 Red
 #9299AM Red

Canister with Handle/Hose

90641AM Premium D4 - White Machine

| Pos. | Part # | Description |
|------|-----------|--|
| 1 | 8001WEER | Bottom casing (2) |
| 2 | 8086 | Castor cpl |
| 3 | 8065ER | Micro filter seal |
| 4 | 8191AM | a) Hospital-grade micro filter & b) Motor filter = Microfilter set |
| 5 | 8084ER | Micro filter holder |
| 6 | 8120AM | Filter bag |
| 7 | 8045ER | Motor support |
| 8 | 8091AM | Internal cable set |
| 9 | 8048ER | 1200W Vac motor (7 & 8) |
| 10 | 665613E | Cord reel |
| 11 | 8009 | Motor inlet seal |
| 12 | 8098ER | Rewind lever spring |
| 13 | 8036ER | Rewind lever cpl (12) |
| 14 | 8085ER | Motor cover cpl (11 & 13) |
| 15 | 8106ER | PCB w/ switch |
| 16 | 8058ER | Retaining ring |
| 17 | 8038ER1 | Power display |
| 18 | 8057 | Spring for power button |
| 19 | 8037GS | Power button |
| 20 | 6047AM/01 | AIRBELT cover (dark gray) |
| 21 | 8033UL | Foam bumper |
| 22 | 8034GS | AIRBELT clip |
| 23 | 8140ER | Filter bag spring w/hardware |
| 24 | 6750ER | Bag cover axle |
| 25 | 8052ER | Bag cover hinge (2 pcs) |
| 26 | 8003WEER | Top casing (23-25) |
| 27 | 8059GS | Cable entry |
| 28 | 8010PRER | Attachment holder cpl |
| 29 | 8114ER | Bag cover release w/axle & spring |
| 30 | 8129GS | Bag cover insert |
| 31 | 8079GS | Hose neck |
| 32 | 7020ER | Bag indicator |
| 33 | 8127ER | Bag indicator adjuster |
| 34 | 8130 | Bag cover seal |
| 35 | 8051AM4 | Inside cover cpl (30-34, 47 & 50) |
| 36 | 8005WEER | Bag cover |
| 37 | 6270GS | Telescopic tube (38&39) |
| 38 | 6420GS | Release button, leaf spring & cap |
| 39 | 6421GS | Slider button w/hardware |
| 40 | 8142GS | Upholstery nozzle |
| 41 | 8146ER | Dusting brush, horsehair |
| 42 | 8066GS | Crevice nozzle |
| 43 | 6391DA | Parquet nozzle |
| 44 | 5266 | Cable clamp |
| 45 | 8119AM | 7' handle with hose |
| 46 | 01000 | Screw C 2.9 x 16 |
| 47 | 01036 | Screw 4 x 14 |
| 48 | 0102 | Screw F 3.9 x 13 |
| 49 | 8160 | Internal cable |
| 50 | 8093 | Hose neck wiring |
| 51 | 8038ER4 | Power display (16,17 & 52) |
| 52 | 8108ER | PCB w/lights |
| 53 | 6369GS | Mains cable |

90640AM PREMIUM D4 - Black (onyx) Machine Exceptions

| | | |
|----|-----------|------------------------|
| 1 | 8001SWER | Bottom casing (2) |
| 20 | 6047AM/02 | AIRBELT cover (silver) |
| 26 | 8003SWER | Top casing (23-25) |
| 36 | 8005SWER | Bag cover |

90630AM D4 - Red Machine Exceptions

| | | |
|----|----------|-----------------------|
| 1 | 8001DRER | Bottom casing (2) |
| 26 | 8003DRER | Top casing (23-25) |
| 28 | 8010D4ER | Attachment holder cpl |
| 36 | 8005DRER | Bag cover |

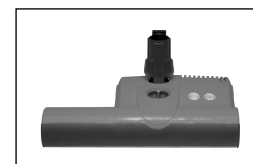

ET-2 Power Head
 optional for D4 Red
 #9250AM Red

SEBO VACUUM CLEANER WARRANTY

1. Your authorized SEBO dealer or SEBO will provide the original product purchaser with replacement of Non-Wear Parts which fail due to a material or workmanship defect for a period of five (5) years from the original date of purchase of new product. SEBO will provide a five (5) year warranty on suction motors and brush drive motors.
2. Your authorized SEBO dealer or SEBO will repair (or will cover labor charges associated with repair) a defective SEBO vacuum cleaner at no cost to the original purchaser, within five (5) years of original purchase of new product in the United States; and within one (1) year of original purchase of new product in Canada.
3. SEBO or an authorized SEBO dealer must complete all warranty repairs.
4. To locate an authorized SEBO dealer in your area, or to register a warranty claim in the **United States of America, please visit our website at www.sebo.us.**
5. To locate an authorized SEBO dealer in your area, or to register a warranty claim in **Canada, please call Floor Care Equipment, Ltd. at (800) 661-8687.**
6. The warranties provided for above apply exclusively to SEBO Vacuum Cleaners which are used residentially. No warranty is provided for SEBO vacuum cleaners used commercially.
7. The Wear Parts excluded from warranty coverage include filter bags, motor filters, micro filters, the cable (external cord), the attachment hose, the brush rollers, the front bottom plate, the rear bottom plate, the crevice nozzle, the upholstery nozzle, the dusting brush, the parquet brush and all of the optional attachments. (See "Identification of Parts" on page 7 of this manual).
8. This warranty applies only while your SEBO Vacuum Cleaner is physically located within the United States of America and its territories or Canada.
9. The purchase receipt showing the date, price, and item of purchase is the initial document of proof of purchase and determines the validity of warranty. To be certain that your warranty claim can be processed as quickly and efficiently as possible, please retain your original purchase receipt and mail in the warranty card provided with your new SEBO vacuum cleaner.
10. This warranty gives you specific legal rights. You may also have other legal rights, which vary from state/province to state/province.
11. SEBO America will not process nor will it accept responsibility for warranty claims for machines purchased from dealers located in Canada. Floor Care Equipment, Ltd. will not process nor will it accept responsibility for warranty claims for machines purchased from dealers located in the United States.

EXCLUSIVE REMEDY: The remedies provided under the terms of this Warranty are the purchaser's exclusive remedies and are in lieu of any other remedies otherwise available.

THE WARRANTY DOES NOT COVER:

- Used or secondhand products.
- Products outside of the warranty period.
- Items not manufactured by SEBO.
- Normal maintenance service.
- Equipment damaged by improper use, accident, other casualty or negligence.
- Machines equipped with nonauthorized attachments or modifications.
- Machines on which the serial number has been altered or removed.

LIMITATIONS AND EXCLUSIONS:

SEBO MAKES NO OTHER REPRESENTATIONS OR WARRANTIES, EXPRESSED OR IMPLIED AND SPECIFICALLY EXCLUDES THE IMPLIED WARRANTIES OF MERCHANTABILITY AND FITNESS FOR A PARTICULAR PURPOSE.

SEBO WILL NOT BE LIABLE FOR INCIDENTAL OR CONSEQUENTIAL DAMAGES OF ANY KIND OR NATURE.

THIS DISCLAIMER OF IMPLIED WARRANTIES SHALL NOT APPLY TO THE EXTENT SAID DISCLAIMER IS NOT ALLOWED BY APPLICABLE STATE/PROVINCIAL LAW.

To contact SEBO in the United States of America:

SEBO America, LLC
 Telephone: (800) 334-6614
 Fax: (303) 792-9196
 Website: www.sebo.us



To contact SEBO in Canada:

Floor Care Equipment, Ltd.
 Telephone: (800) 661-8687
 Fax: (800) 270-4807
 Website: www.sebocanada.ca



MADE IN GERMANY